

Accessories

TRIM

DUCT BOTTOM

DUCT UPPER

SCREW A

SCREW B

NO.	PART NAME PART CODE	Q'TY
1	TRIM	1
2	DUCT BOTTOM	1
3	DUCT UPPER	1
4	SCREW A	8
5	SCREW B (For wood)	8

Size of installation shown as right sketch

W	H	D
Minimum	Minimum	Minimum
20"	13 3/8"	14 1/8"
(51cm)	(33.96cm)	(35.87cm)

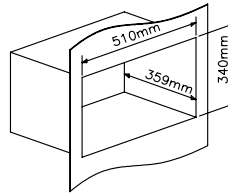
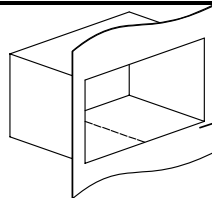

FIG.1

Step 1:

Please refer to the right sketch, draw the center line on the duct bottom of the cabinet.



center line of the cabinet

FIG.2

Step 2:

In order to fix the duct bottom in the central of the cabinet, please ensure the mark on the front brim at the front cabinet and it is parallel to the central line of the cabinet. Pls refer the right sketch. And fix with 4 screws B

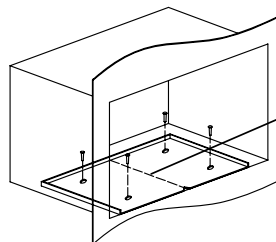

the mark aim at the center line

Duct bottom and cabinet aligned as shown.

FIG.3

Step 3:
Take TRIM and check it.

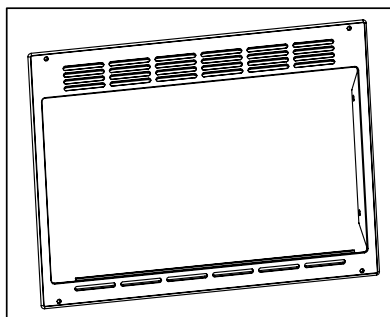

FIG.4

Step 4.
Fix TRIM to the Oven as shown in FIG.5.
Use 4 screws A to fasten the TRIM at points indicated in FIG.5

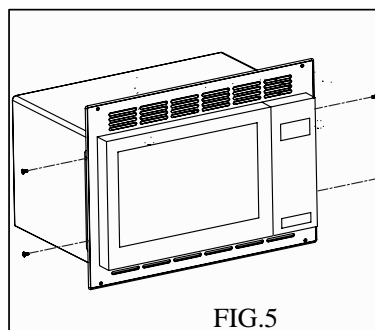

FIG.5

Step 5
Install the DUCT UPPER on the cover,
fixed with 4 screws A.

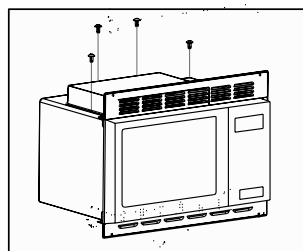

FIG.6

Step 6
Please push the Microwave Oven into the cabinet, then fix the TRIM to the Cabinet with 4 screws B.

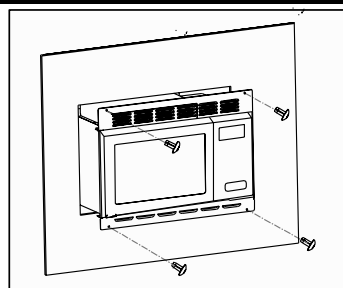

FIG.7